



#1 IN THE WORLD



2009
RPHA 10



2011
RPHA 10 plus

A stylized world map in shades of blue and white, serving as a background for the text. The map is centered and shows the outlines of continents.

From **2010** to **2014**

Over **60** Countries

Over **600,000** Sold

PERFORMANCE
REINVENTED



RPHA 11



Aerodynamic **Design**

Improved Aerodynamic Shell Design

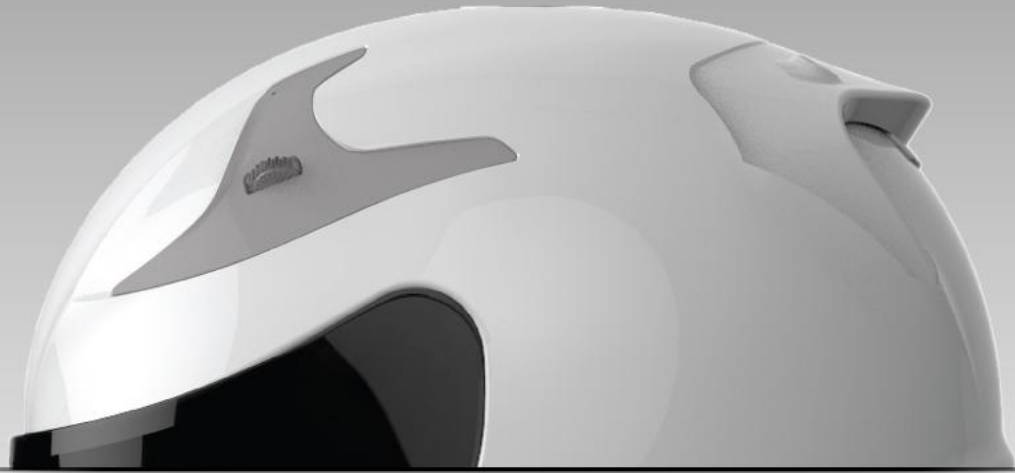

RPHA 10^{plus}



RPHA 11

Redefined Aerodynamic Shape

Hours upon Hours of Testing in Our Own HJC Wind Tunnel

Aerodynamic Shell Bottom Design



RPHA 10^{plus}



RPHA 11

New Shape at the Bottom of the Shell for Greater Comfort

New Rear Spoiler Design



RPHA 10^{plus}



RPHA 11

*Cuts Through the
Air More Efficiently
Rain Proof Design*



Advanced **Technology**

P.I.M. Plus Shell Construction



- Glass Fiber
- Organic Non-Woven Fabric
- Carbon Fiber
- Carbon-Glass Hybrid Fiber
- Aramid Fiber
- Glass Fiber

*Advanced **Ventilation***

“ACS” Advanced Channeling Ventilation System



A Total of

14 *VENTS*

to Provide Superior Air Flow

New Forehead Vent



*Increase Air Intake
and Channels Cooling
Air for Improved
Circulation*

Aerodynamic Top Vent with Precision Top-Vent Control



*Glove-friendly Scroll Switch
with Rubber Trim Rim*



Rain Proof

*Multi-position
Top Vent Control*

Dual Mouth Side Vents

Newly Designed Mouth Side Vents



Mouth Side Vent Slider

CLOSE



OPEN

Air Channel System Interior



RPHA 10^{plus}



RPHA 11

Maximize the Flow of Air from Front to BAck

Wind Tunnel Test Comparison Chart



- Top Side Vent
- Forehead Vent
- Mouth Side Vent
- Mouth Vent



- Rear Spoiler
- Rear Side Vent



MODEL	Intake/Exhaust Test					
	Forehead Vent	Top Side Vent	Mouth Vent	Mouth Side	Rear Spoiler	Rear Side Vent
RPHA 11	0.59 ★	0.71 ★	0.49	0.47	-0.42 ★	-0.31 ★
			0.96 ★			
RPHA 10 PLUS	-	0.68	0.62	-	-0.3	-
COMPETITOR	0.32	0.27	0.84	-	-0.25	-

*Advanced **Shield System***

RAPIDFIRE 2[®] Shield Replacement System



SIMPLE

SECURE

ULTRA-QUICK

TOOL-LESS

Multi-Point Locking System



RPHA 10^{plus}

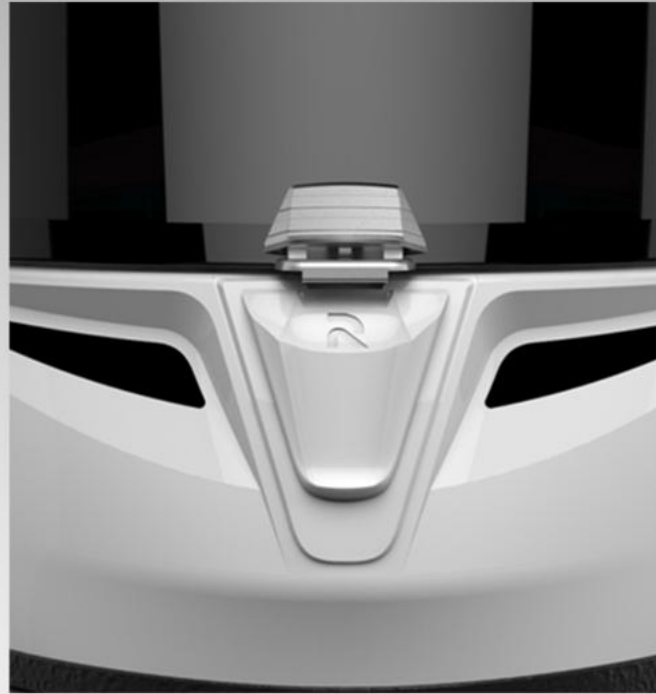

RPHA 11

*Clean and
Simple Design*

*Extra-Secure
Shield Seal*

Enlarged View Port



5mm (3°)

Improved Rider View Range

RPHA 11

RPHA 10^{plus}

New-Designed Gasket System

RPHA 10^{plus}

RPHA 11

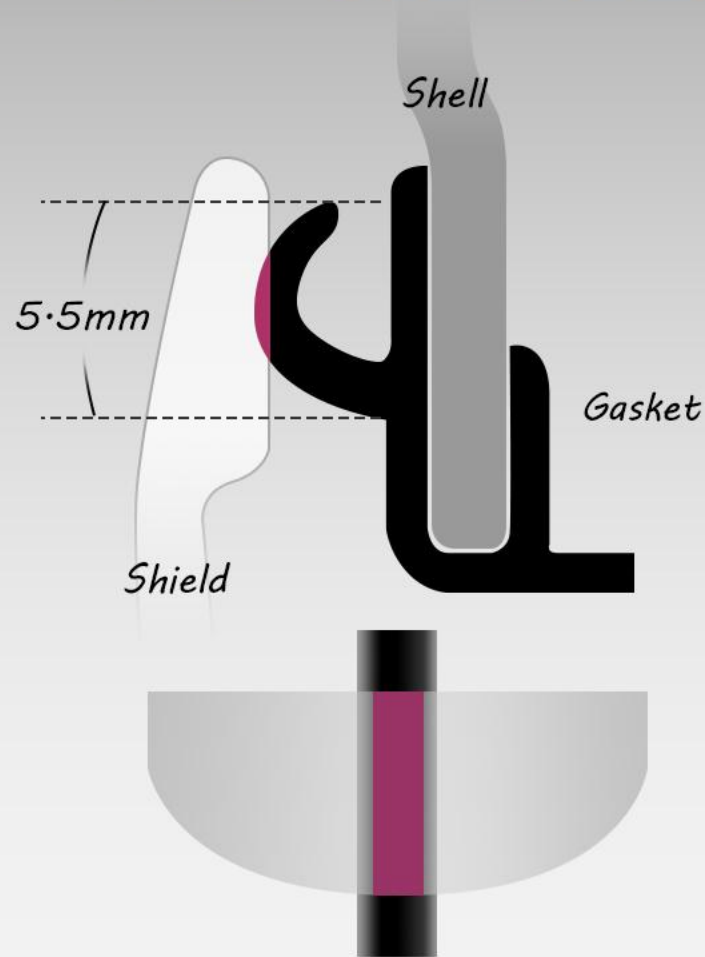
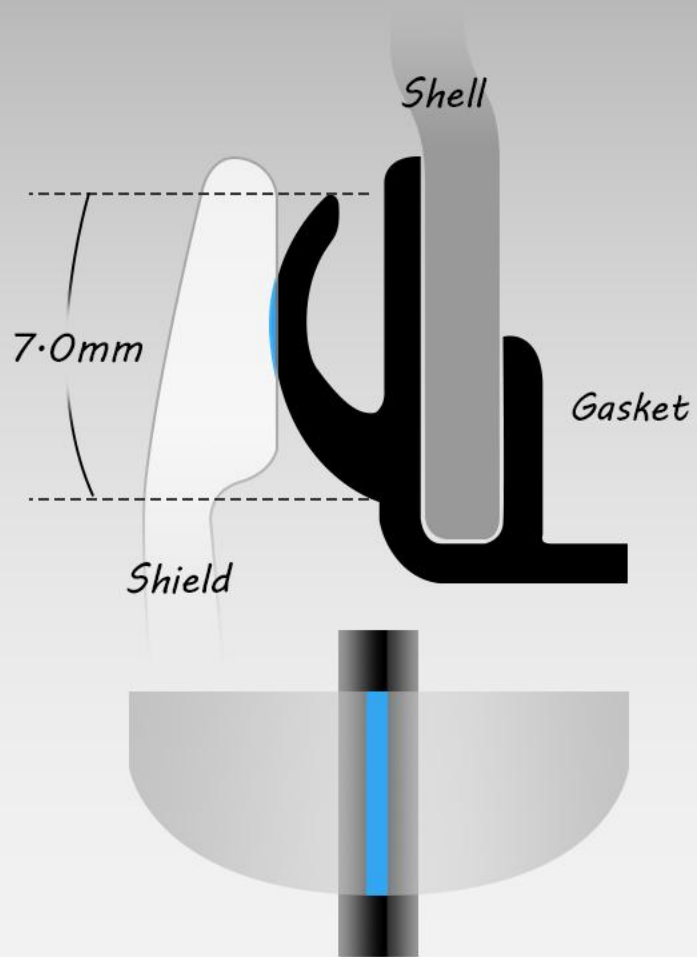

*Air-tight Seal
Around the Entire
Shield Perimeter*

Optically-Superior Pinlock®-Prepared 2D Flat-Racing Shield



2D Clear Shield Included



2D Dark Smoke Shield Included



Fog-resistant Insert Lens Included

Luxury and Comfort **Interior**

Premium MultiCool™ Interior



Illustration to be placed here

Anti-bacterial

Moisture-wicking

Odor-free

Quick drying

Removal

Washable

Glasses-friendly Interior



*Special Channels Built
into the Helmet Interior*

Nose Deflector Made with Eco-Friendly Material

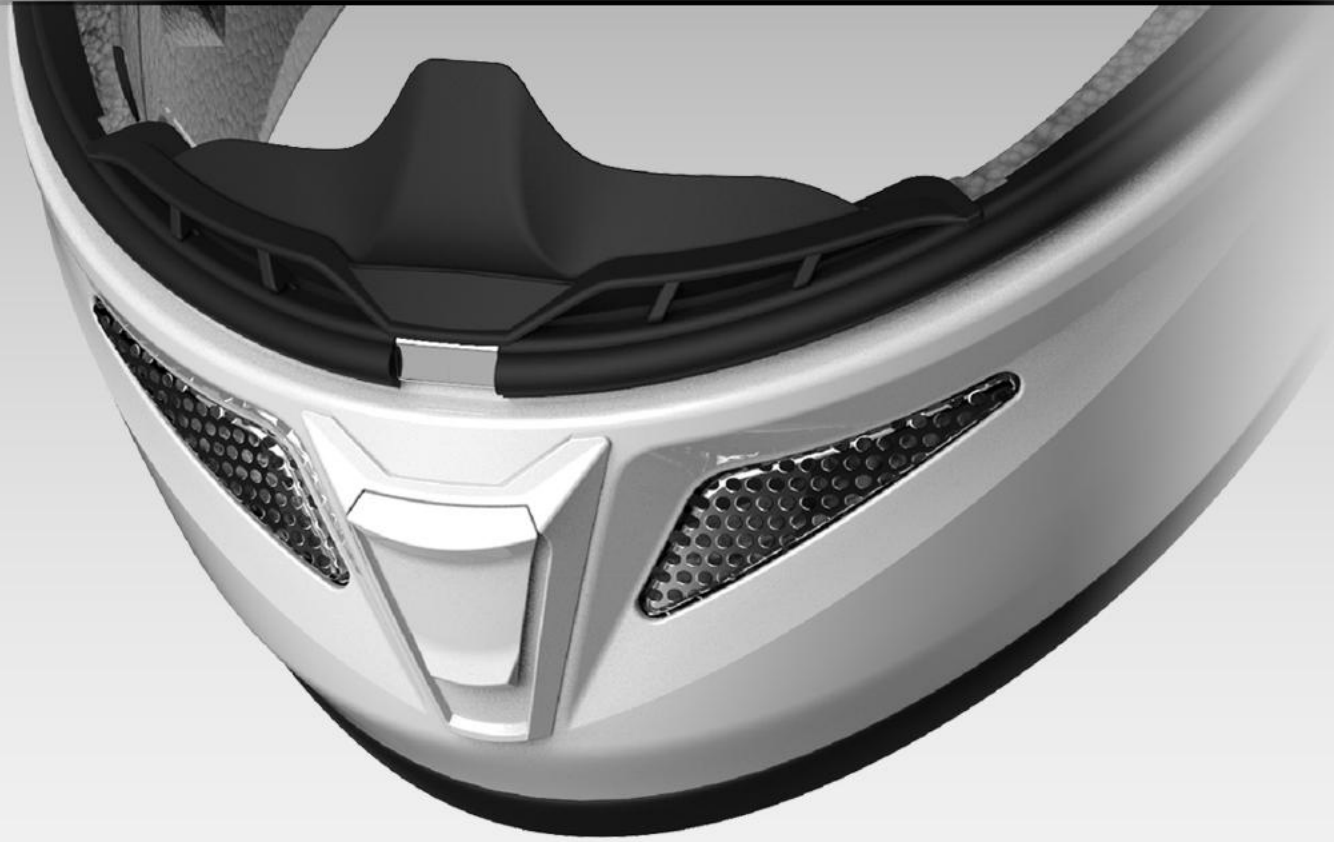

*Safe for the Environment
Safe for Your Health*



Communications **Options**

Speaker Pockets

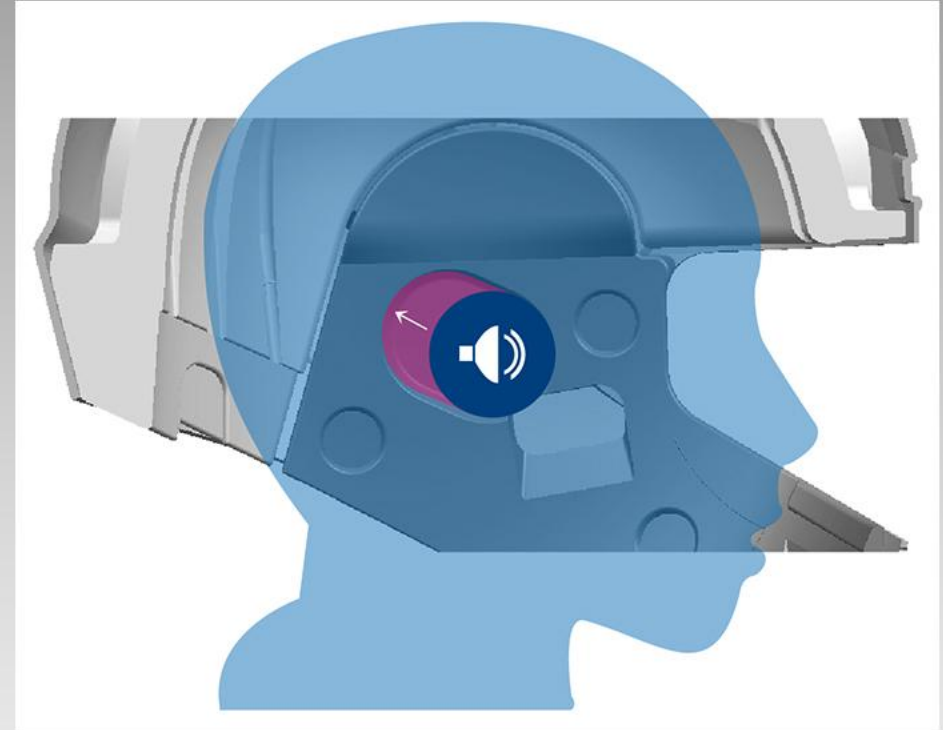
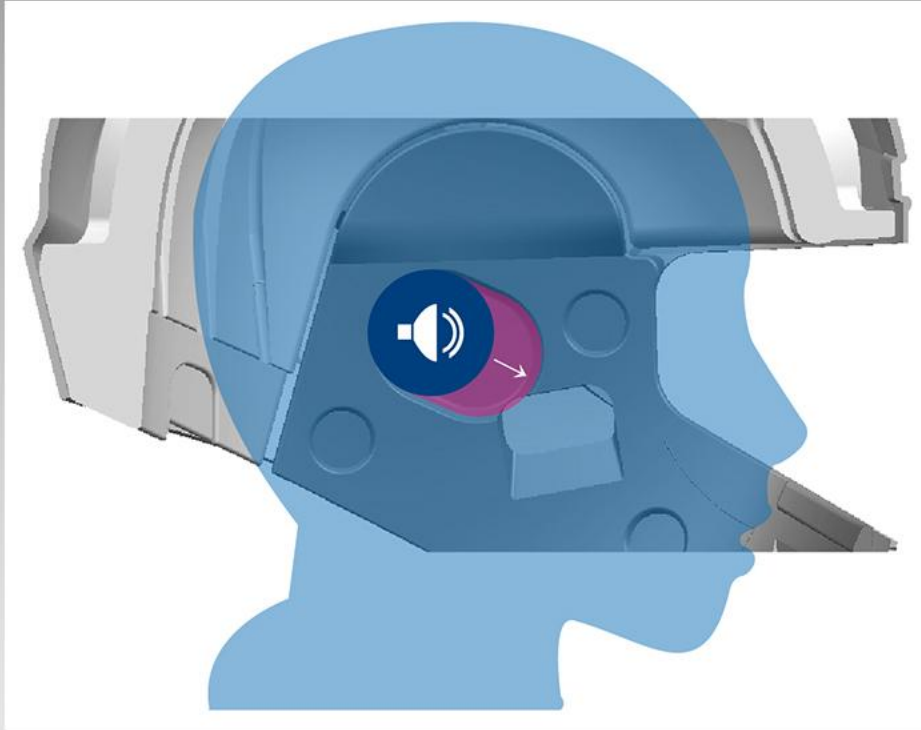

Built into the Sides of the Inner Shell

Flexibility in Speaker Placement for a Custom Fit

*Advanced **Noise Control***

New Dual-Compound Ear Pads

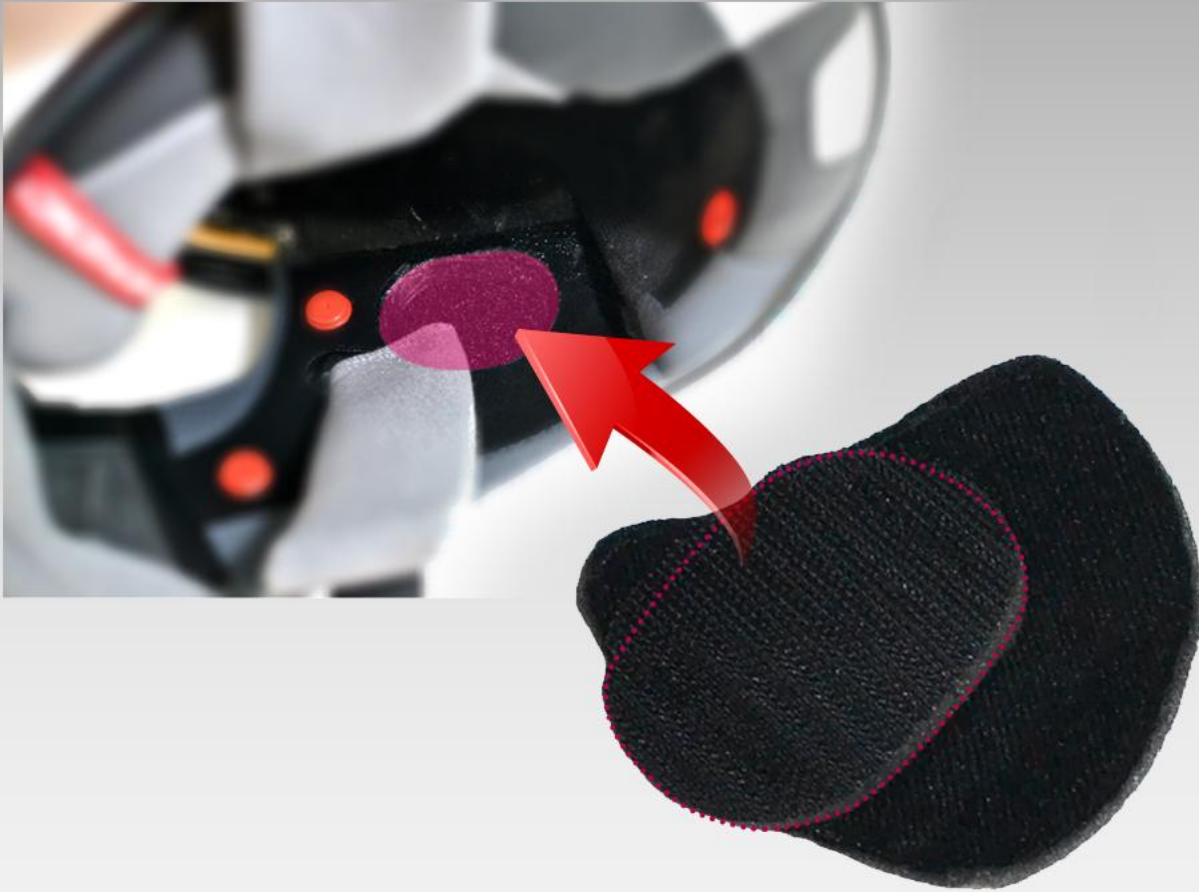

Help block out noise

*Produce Maximum Comfort
and Effectiveness*

Enhanced **Safety**

High-Visibility Reflective Patches



*Located on the Bottom of
the Interior Pads at
the Rear of the Helmet*

*Increase Nighttime
Rider Conspicuity*

Emergency Kit

Allows Quick Removal of the Helmet Cheek Pads for Emergency





RPHA 10 plus

1250g

RPHA 11

1300g



RPHA 10 plus



RPHA 11



RPHA 11





#1 IN THE WORLD